

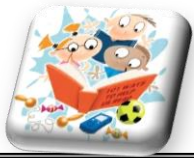

MY VOCABULARY GAME n°...

WORD PUZZLE

Words and translations



MY VOCABULARY GAME n°...

WORD PUZZLE

Words and translations

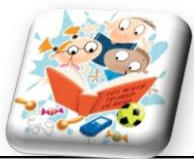

MY VOCABULARY GAME n°...

WORD PUZZLE

Words and translations

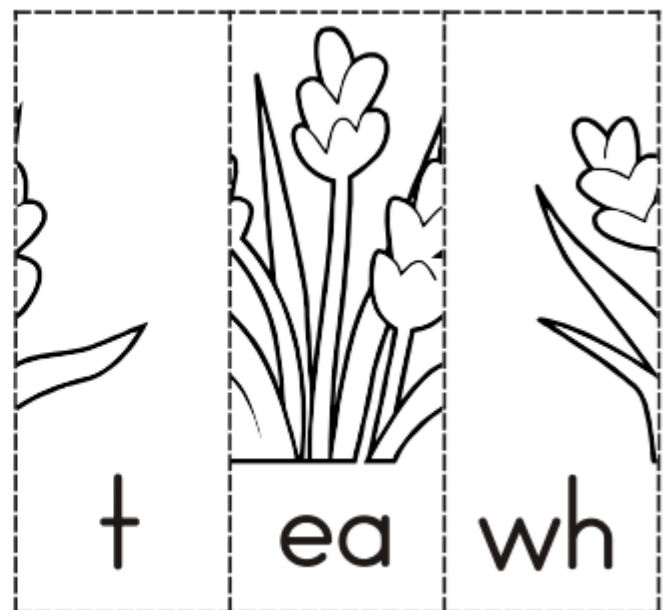
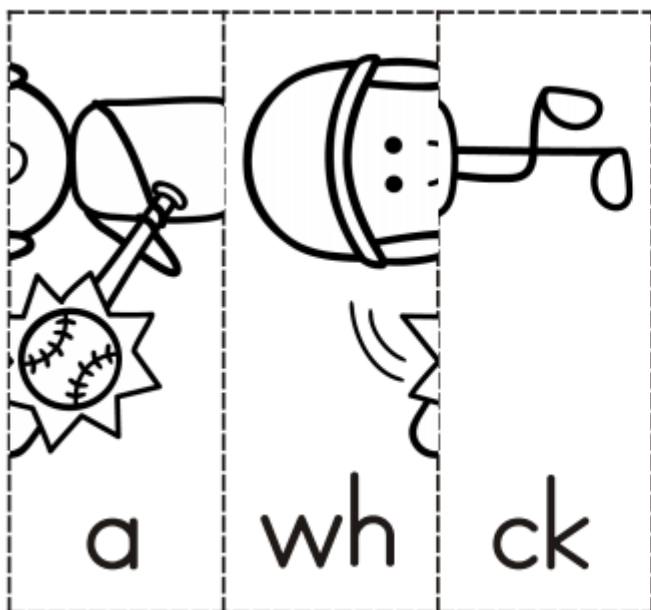
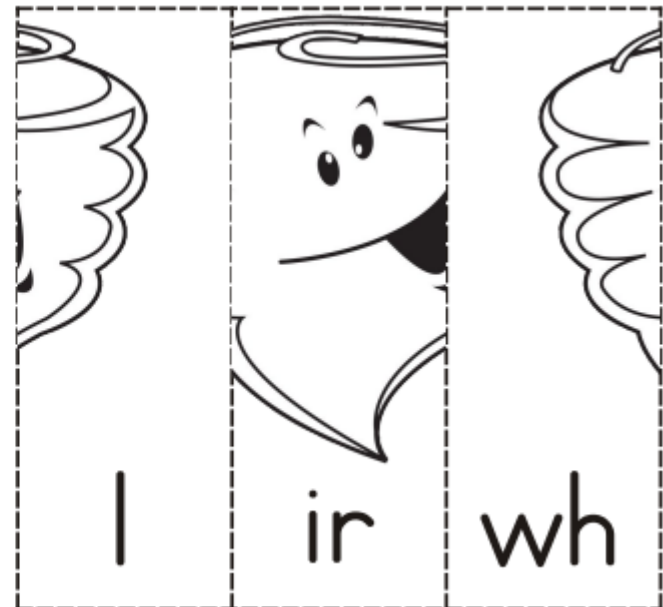
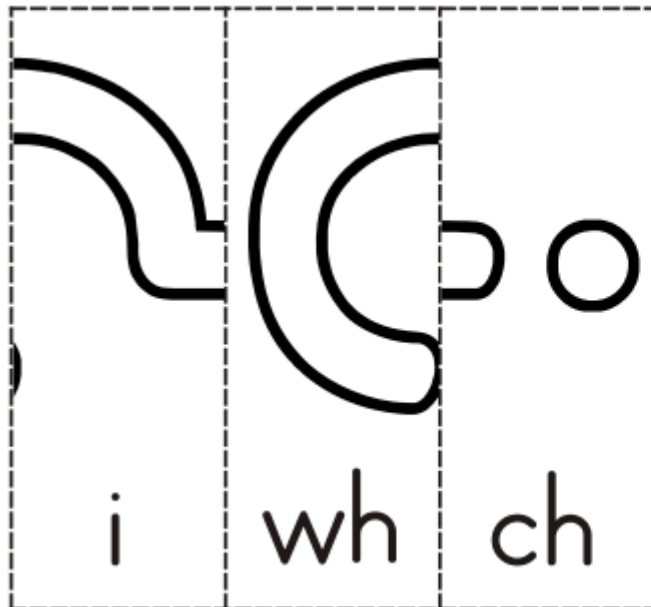
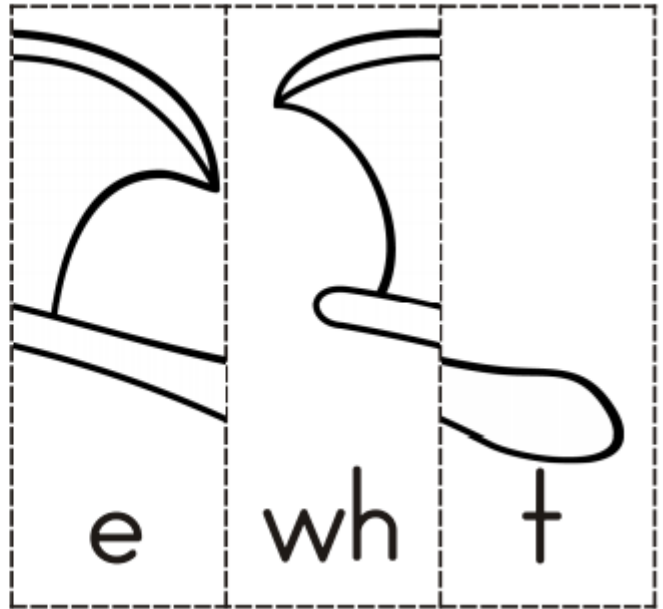
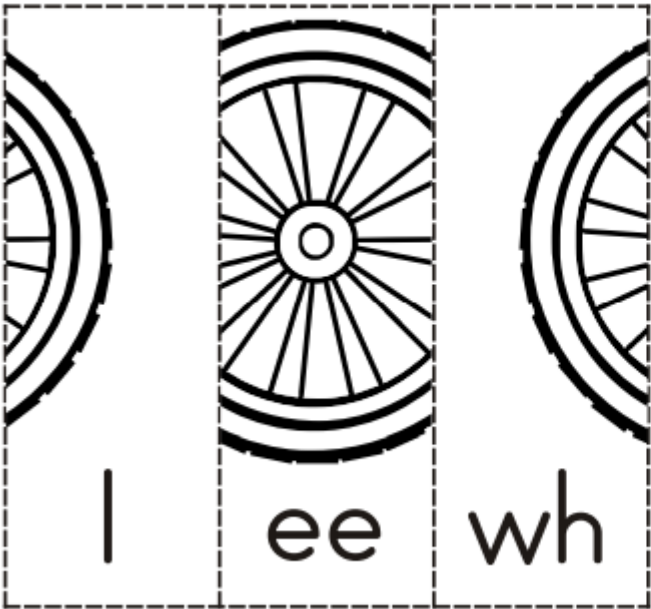

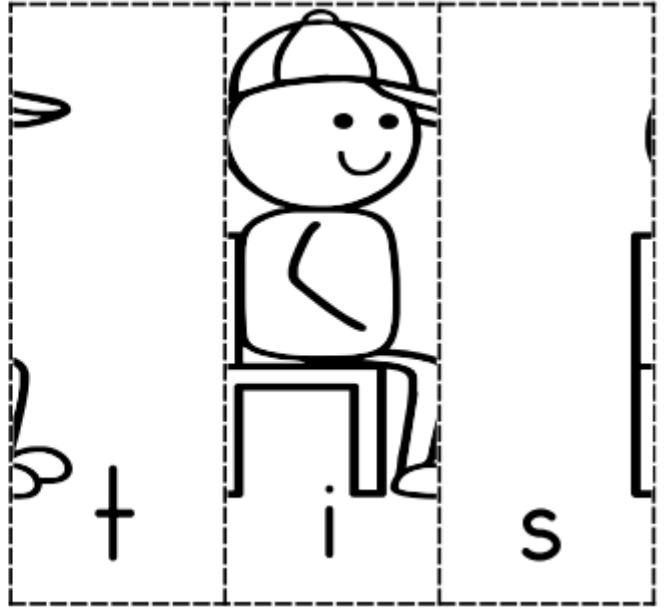
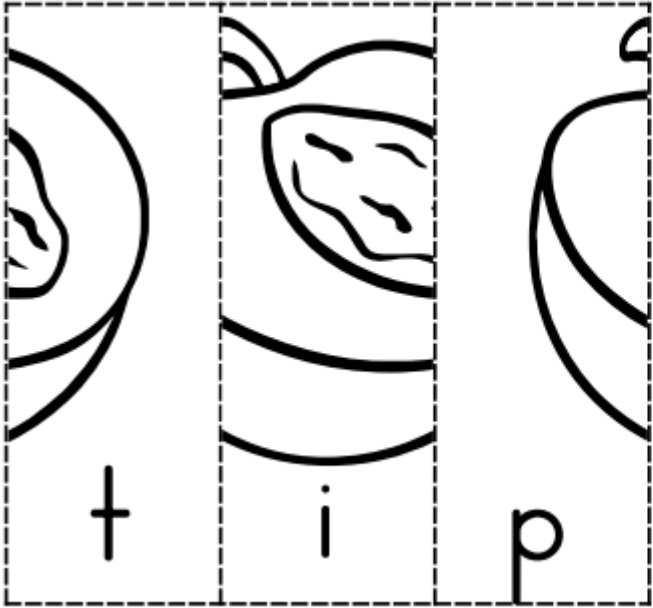
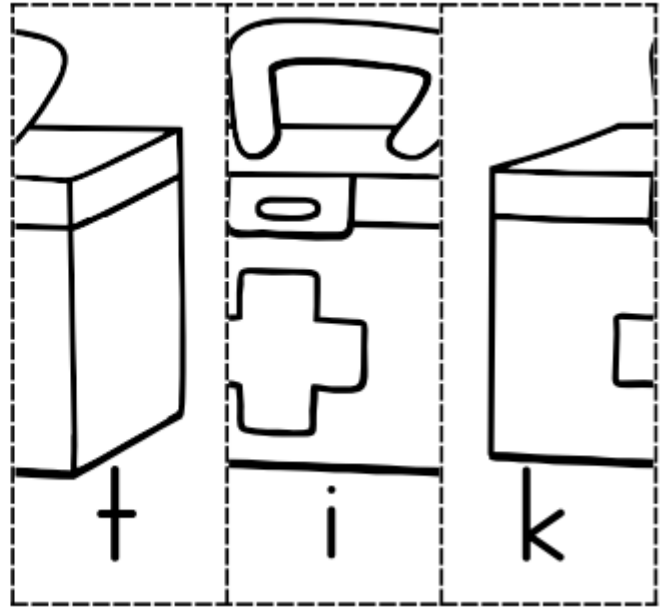
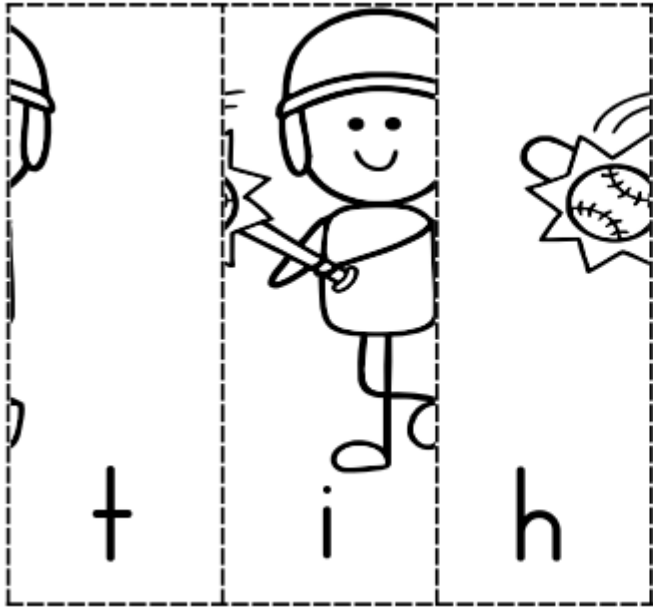
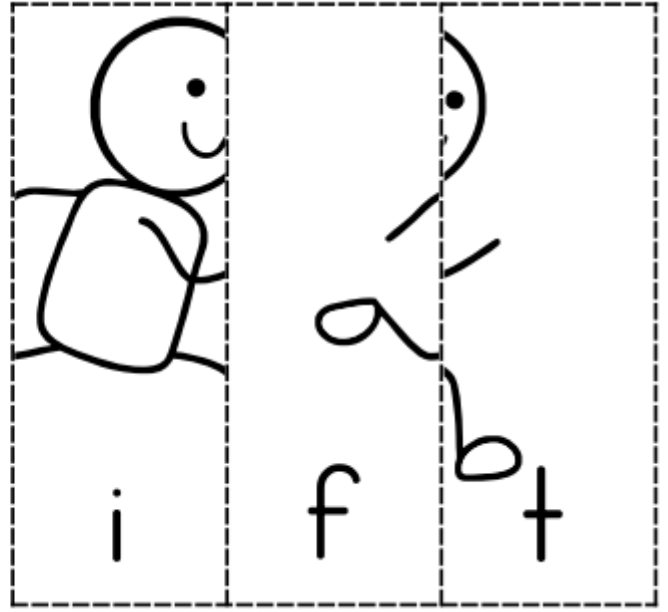
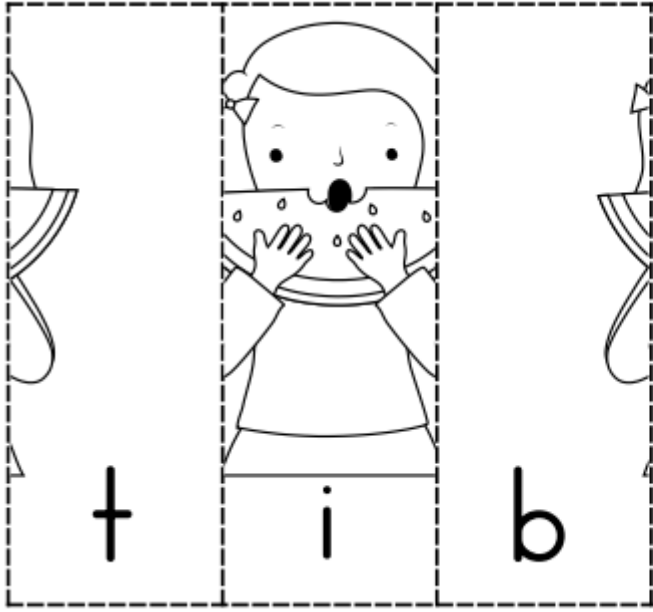

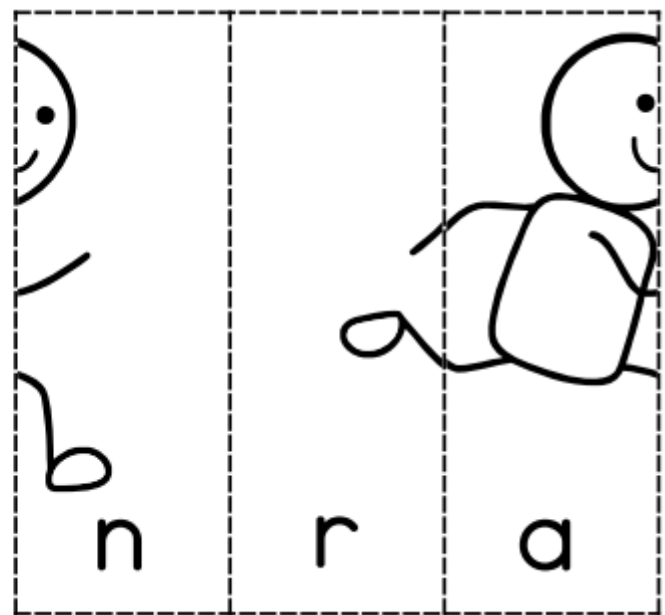
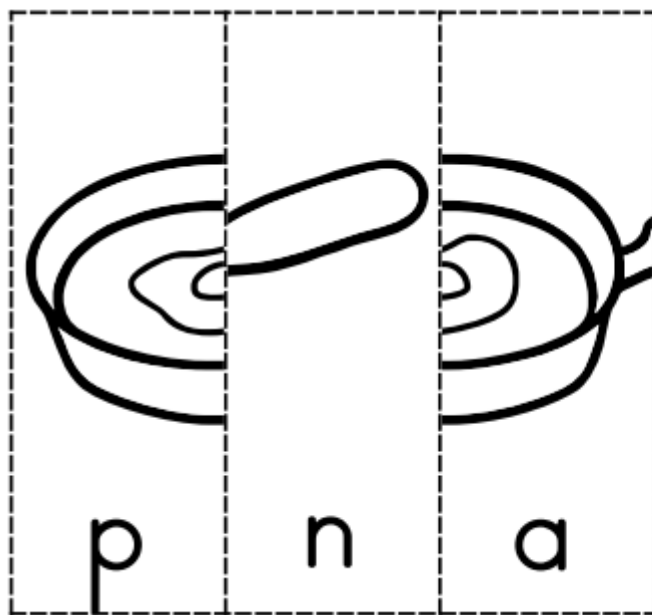
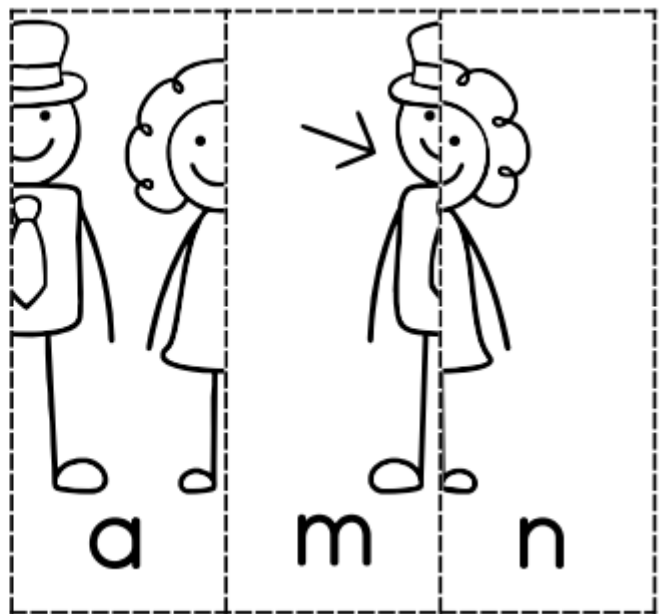
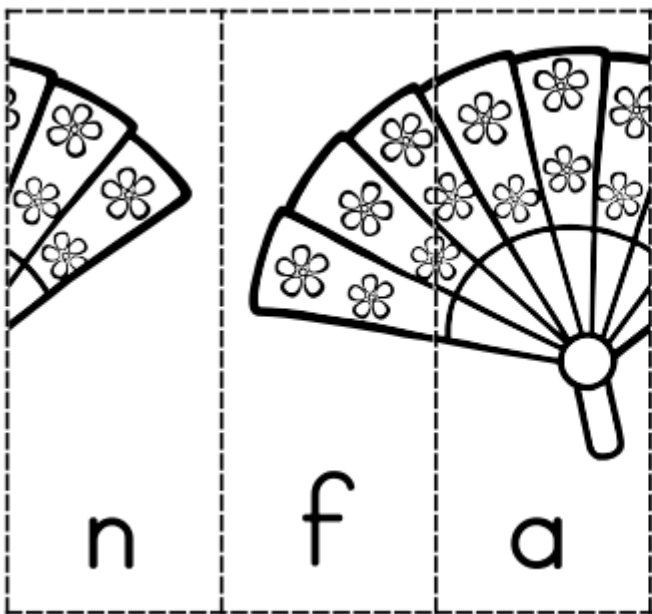
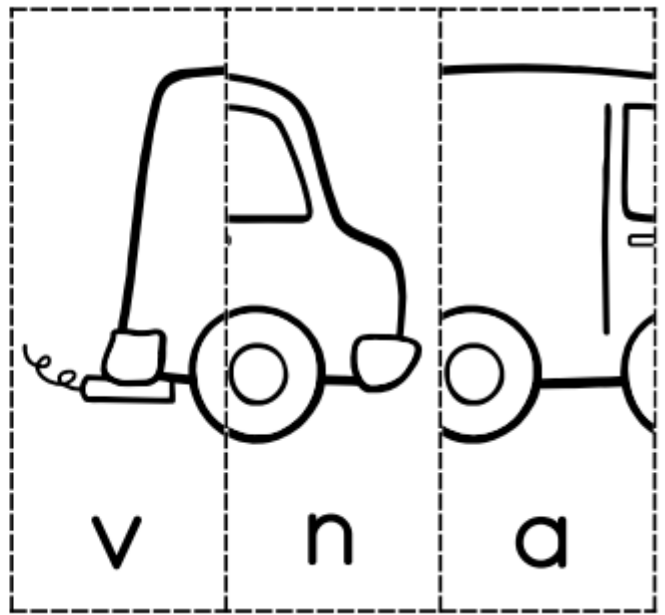
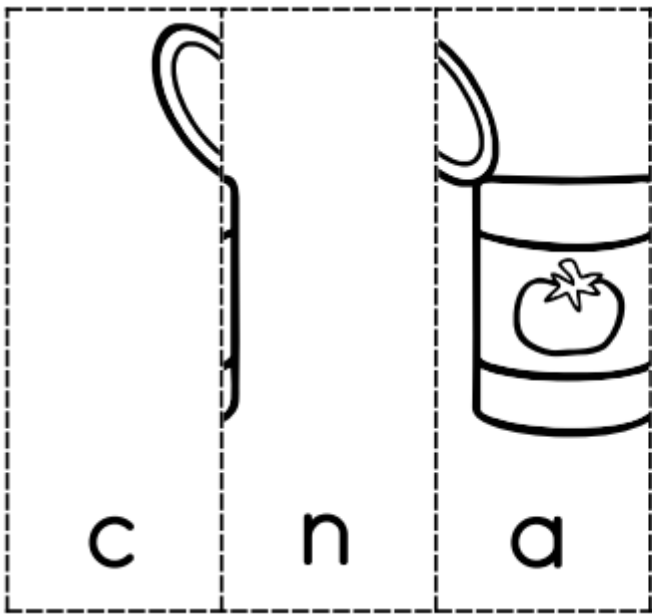

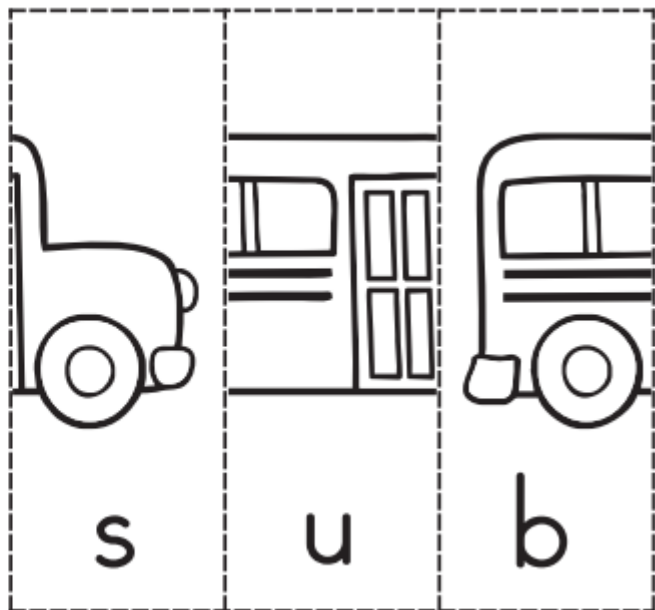
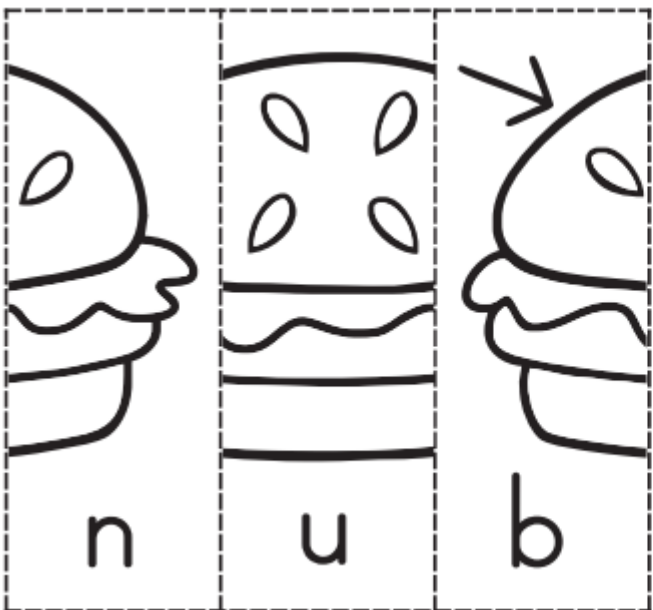
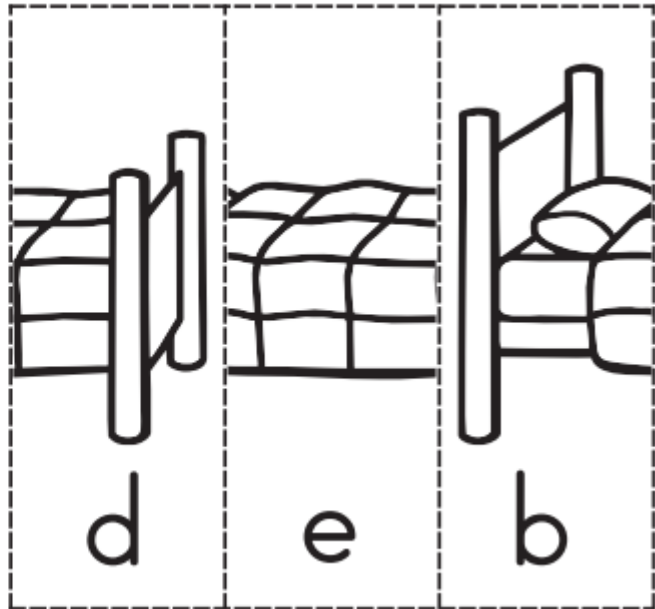
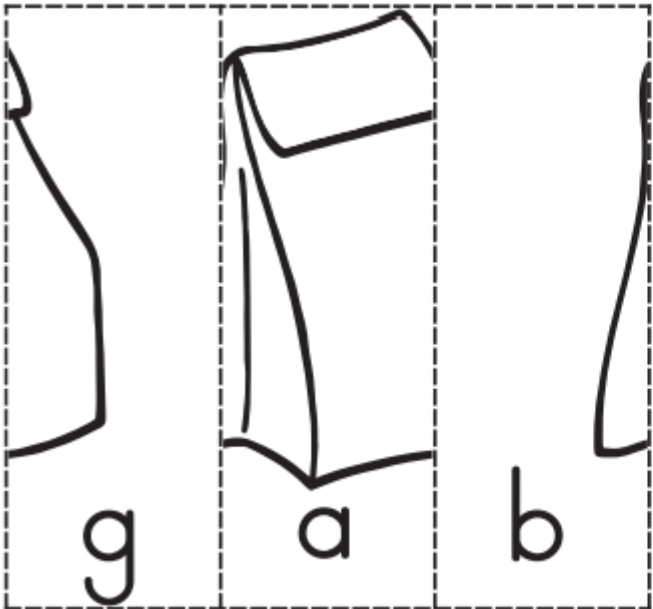
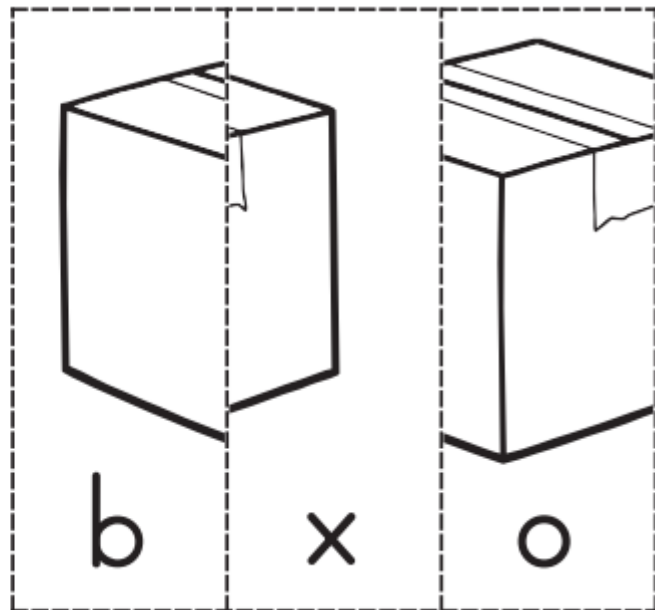
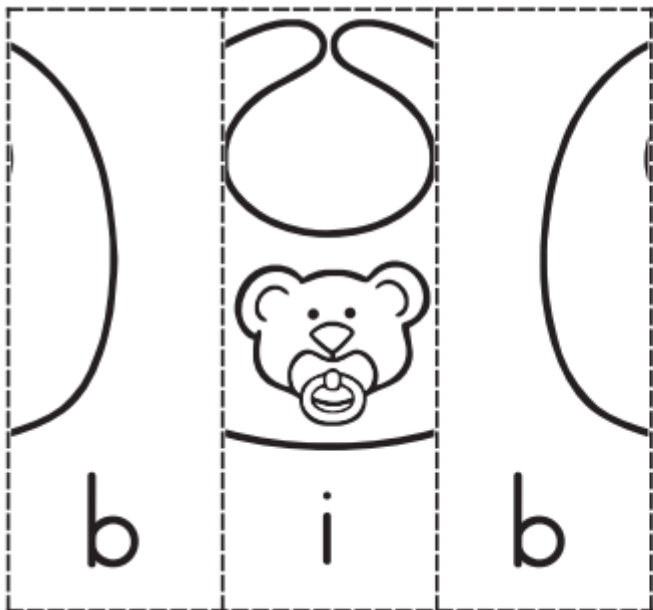

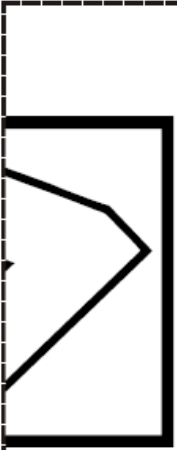

ck

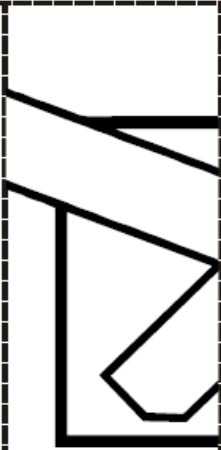

e



ch

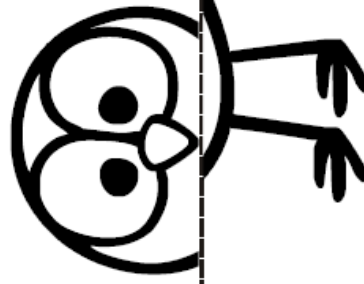

ch

ck

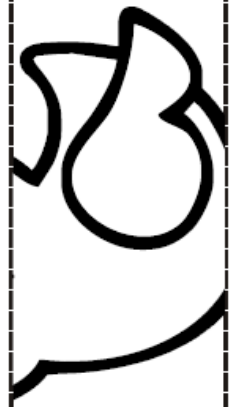

i



ch

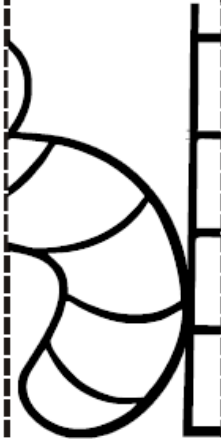

n



i

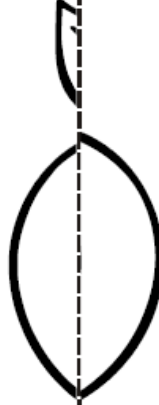

p

ch

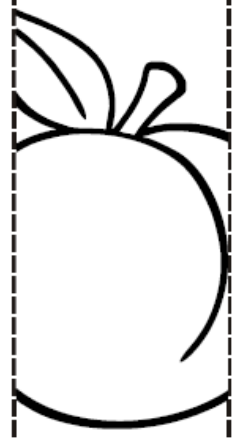

ea



ch



i



r

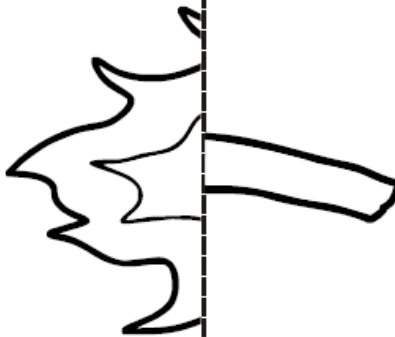

t

ch



or

